

REV	DATE	DESCRIPTION
A	12/12/18	INITIAL RELEASE
B	04/16/20	ADDED CABLE GLANDS

THE INFORMATION CONTAINED IN THIS DRAWING IS THE SOLE PROPERTY OF ALTELIX LLC. ANY REPRODUCTION IN PART OR WHOLE WITHOUT THE WRITTEN PERMISSION OF ALTELIX LLC IS PROHIBITED. ALL SPECIFICATIONS SUBJECT TO CHANGE WITHOUT NOTICE. (C) 2017 ALTELIX LLC.

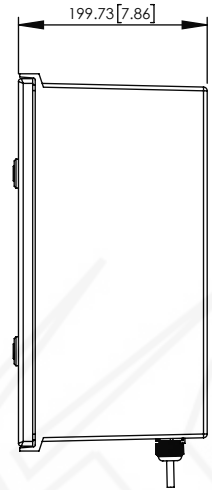

SECTION A-A

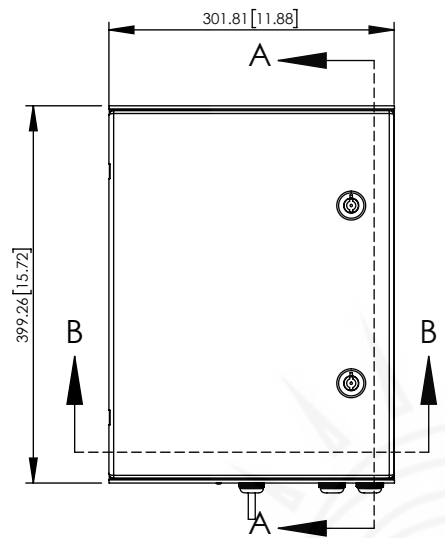
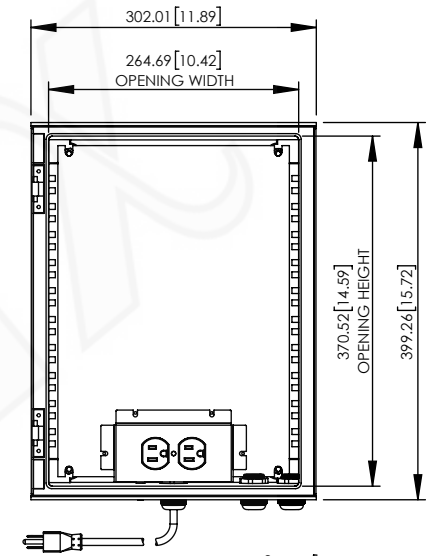
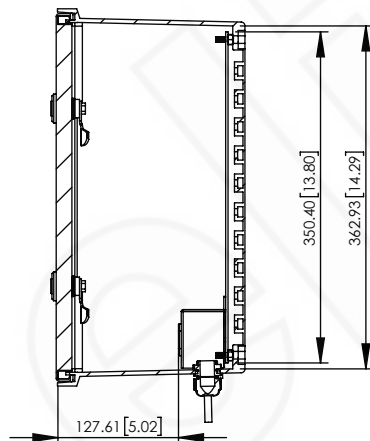

SECTION B-B

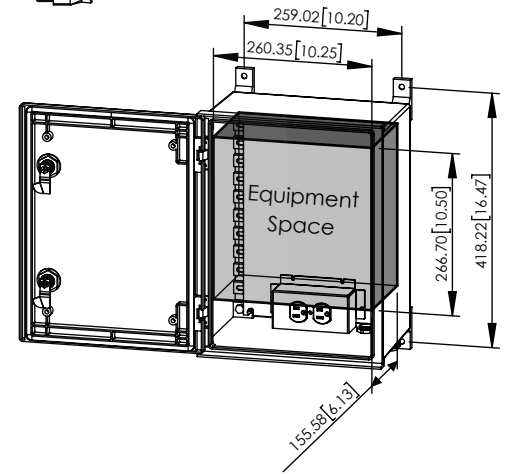
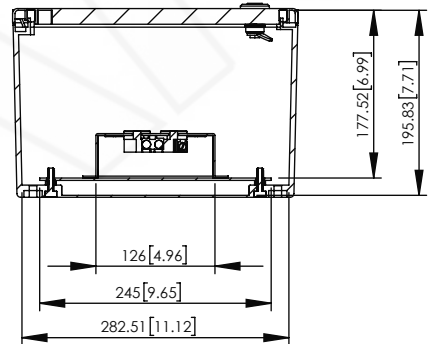
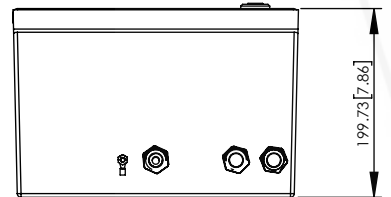

NO.	DESCRIPTION	MATERIAL	FINISH	QTY.
8	-	-	-	-
7	-	-	-	-
6	-	-	-	-
5	-	-	-	-
4	-	-	-	-
3	-	-	-	-
2	-	-	-	-
1	NEMA ENCLOSURE	FIBER REINFORCED POLYESTER	-	1

UNLESS OTHERWISE SPECIFIED:  
DIMENSIONS ARE IN MILLIMETERS.  
DIMENSIONS IN [ ] ARE IN INCHES AND  
ARE FOR CUSTOMER REFERENCE ONLY.

TOLERANCES FOR MILLIMETERS:  
0.5-8mm ± 0.20mm  
8-30mm ± 0.40mm  
30-120mm ± 0.50mm

TASK	NAME	DATE
DRAWN BY	N. COLUCCI	12/12/18
CHECKED	-	-
APPROVED	-	-

1201 Clint Moore Road  
Boca Raton, FL 33487  
TEL: 561-660-WIFI  
www.altelix.com

PART DESCRIPTION			
16 X 12 X 8 NEMA ENCLOSURE WITH 120VAC			
PART NUMBER		NFC161208A1C	
DRAWING NUMBER		DRW-NFC161208A1C	
SCALE:	1:8	REV:	B
		SHEET 1 OF 1	