

REV	DATE	DESCRIPTION
A	02/20/18	INITIAL RELEASE

THE INFORMATION CONTAINED IN THIS DRAWING IS THE SOLE PROPERTY OF ALTELIX LLC. ANY REPRODUCTION IN PART OR WHOLE WITHOUT THE WRITTEN PERMISSION OF ALTELIX LLC IS PROHIBITED. ALL SPECIFICATIONS SUBJECT TO CHANGE WIHTOUT NOTICE. (C) 2017 ALTELIX LLC.

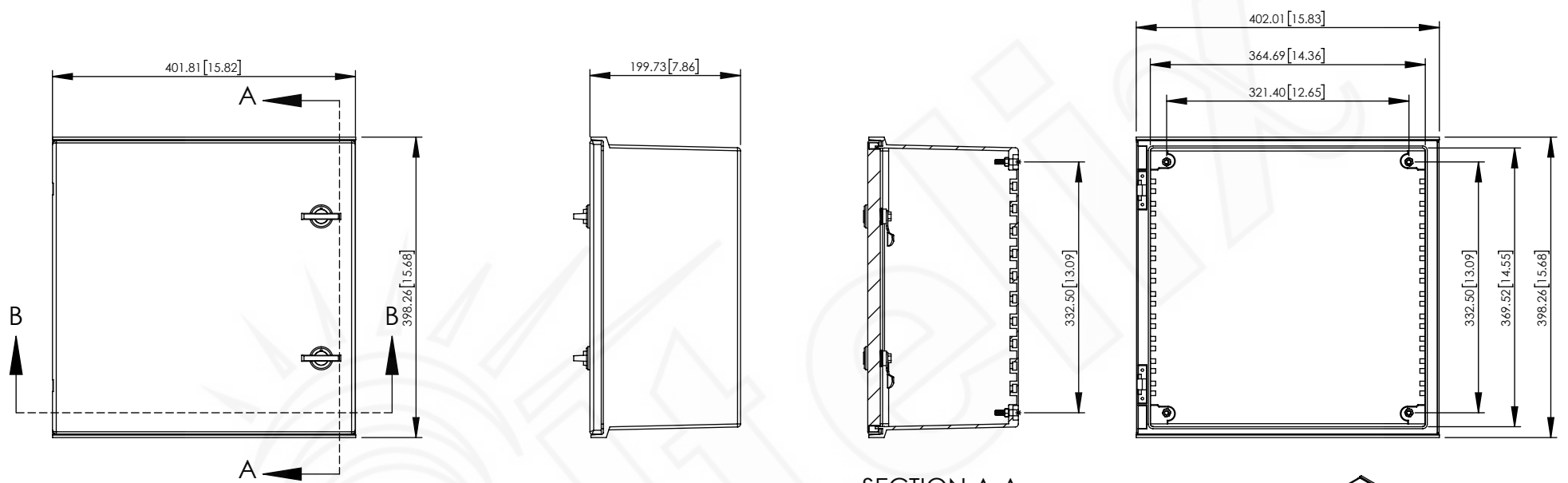

SECTION A-A

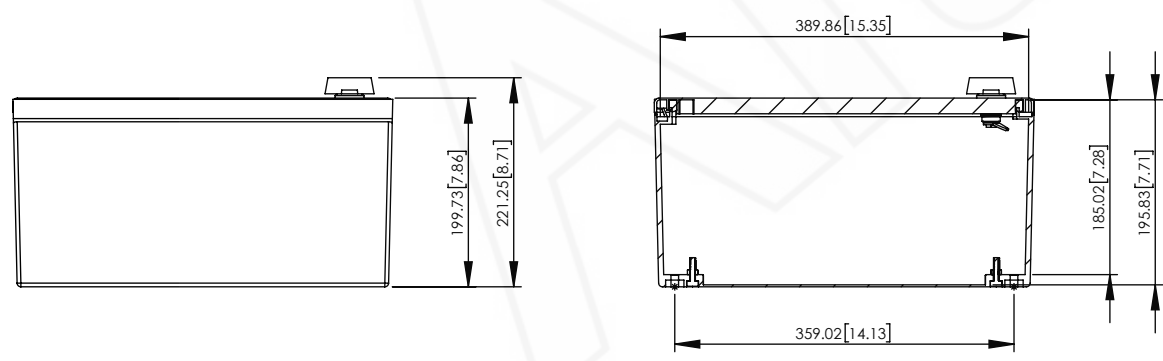

SECTION B-B

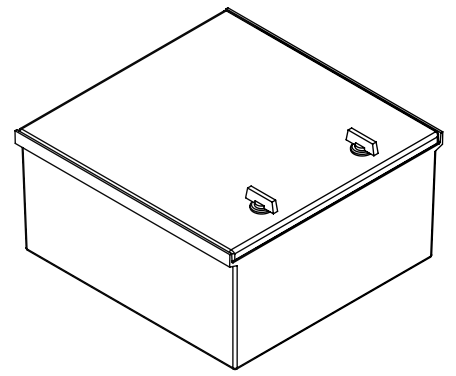

NO.	DESCRIPTION	MATERIAL	FINISH	QTY.
8	-	-	-	-
7	-	-	-	-
6	-	-	-	-
5	-	-	-	-
4	-	-	-	-
3	-	-	-	-
2	-	-	-	-
1	NEMA ENCLOSURE	FIBER REINFORCED POLYESTER	-	1

UNLESS OTHERWISE SPECIFIED:
 DIMENSIONS ARE IN MILLIMETERS.
 DIMENSIONS IN [] ARE IN INCHES AND
 ARE FOR CUSTOMER REFERENCE ONLY.

TOLERANCES FOR MILLIMETERS:
 0.5-8mm ± 0.20mm
 8-30mm ± 0.40mm
 30-120mm ± 0.50mm

TASK	NAME	DATE
DRAWN BY	N. COLUCCI	02/20/18
CHECKED	-	-
APPROVED	-	-

Altelix
 www.altelix.com

1201 Clint Moore Road
 Boca Raton, FL 33487
 TEL: 561-660-WIFI

PART DESCRIPTION			
16 X 16 X 8 NEMA ENCLOSURE			
PART NUMBER		NFC161608	
DRAWING NUMBER		DRW-NFC161608	
SCALE:	1:8	REV:	A
			SHEET 1 OF 1