

REV	DATE	DESCRIPTION
A	11/27/18	INITIAL RELEASE
B	06/17/20	ADDED CABLE GLANDS

THE INFORMATION CONTAINED IN THIS DRAWING IS THE SOLE PROPERTY OF ALTILIX LLC. ANY REPRODUCTION IN PART OR WHOLE WITHOUT THE WRITTEN PERMISSION OF ALTILIX LLC IS PROHIBITED. ALL SPECIFICATIONS SUBJECT TO CHANGE WIHTOUT NOTICE. (C) 2017 ALTILIX LLC.

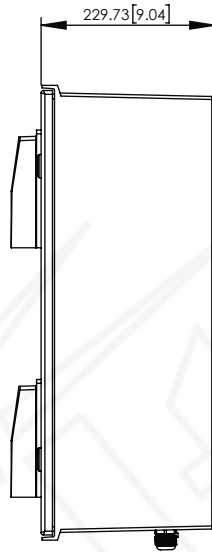

SECTION A-A

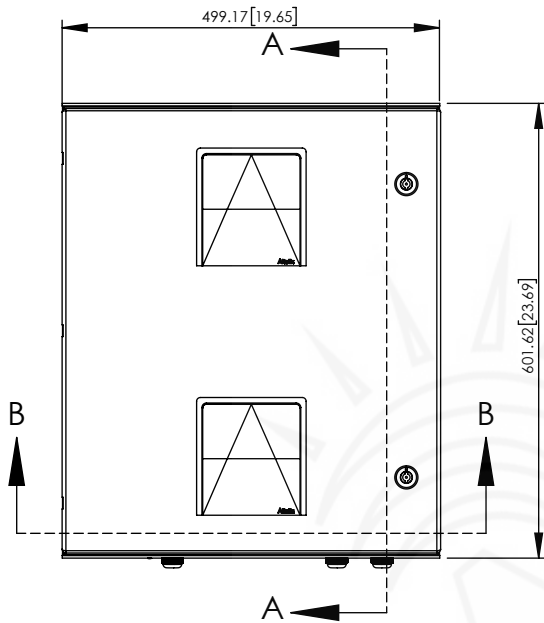
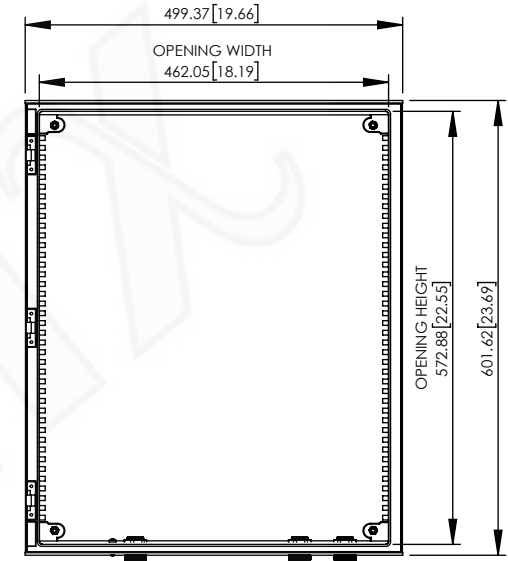
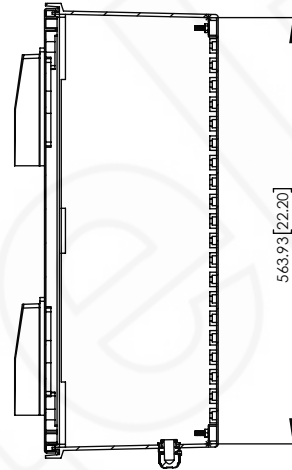

SECTION B-B

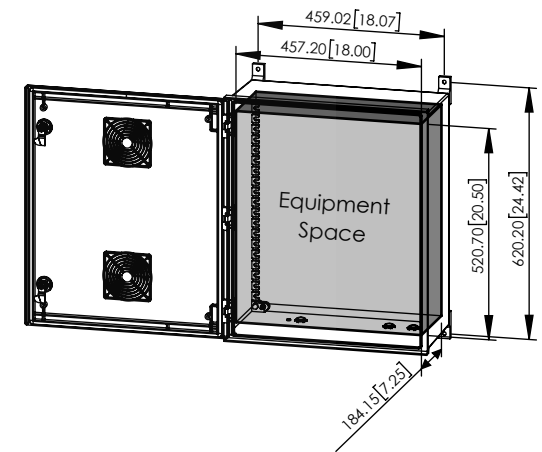
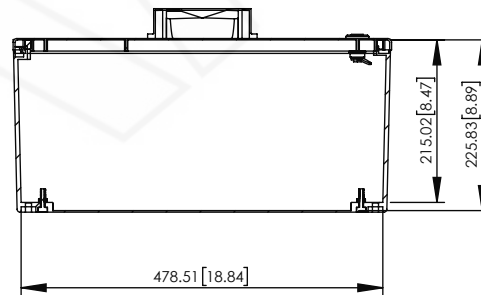
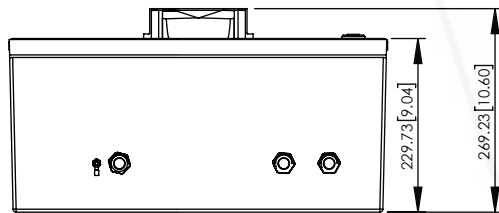

NO.	DESCRIPTION	MATERIAL	FINISH	QTY.
8	-	-	-	-
7	-	-	-	-
6	-	-	-	-
5	-	-	-	-
4	-	-	-	-
3	-	-	-	-
2	-	-	-	-
1	NEMA ENCLOSURE	FIBER REINFORCED POLYESTER	-	1

UNLESS OTHERWISE SPECIFIED:  
DIMENSIONS ARE IN MILLIMETERS.  
DIMENSIONS IN [ ] ARE IN INCHES AND  
ARE FOR CUSTOMER REFERENCE ONLY.

TOLERANCES FOR MILLIMETERS:  
0.5-8mm ± 0.20mm  
8-30mm ± 0.40mm  
30-120mm ± 0.50mm

TASK	NAME	DATE
DRAWN BY	N. COLUCCI	11/27/18
CHECKED	-	-
APPROVED	-	-



1201 Clint Moore Road  
Boca Raton, FL 33487  
TEL: 561-660-WIFI

PART DESCRIPTION		
24 X 20 X 9 VENTED NEMA ENCLOSURE		
PART NUMBER		NFC242009V
DRAWING NUMBER		DRW-NFC242009V
SCALE: 1:10	REV: B	SHEET 1 OF 1