

REV	DATE	DESCRIPTION
A	11/27/08	INITIAL RELEASE

THE INFORMATION CONTAINED IN THIS DRAWING IS THE SOLE PROPERTY OF ALTELIX LLC. ANY REPRODUCTION IN PART OR WHOLE WITHOUT THE WRITTEN PERMISSION OF ALTELIX LLC IS PROHIBITED. (C) 2018 ALTELIX LLC.

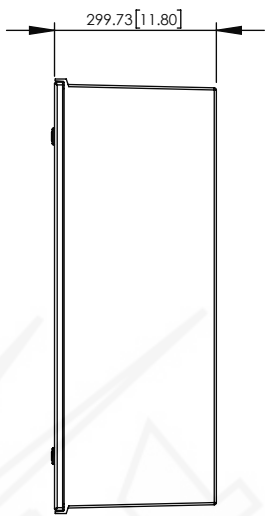

SECTION A-A

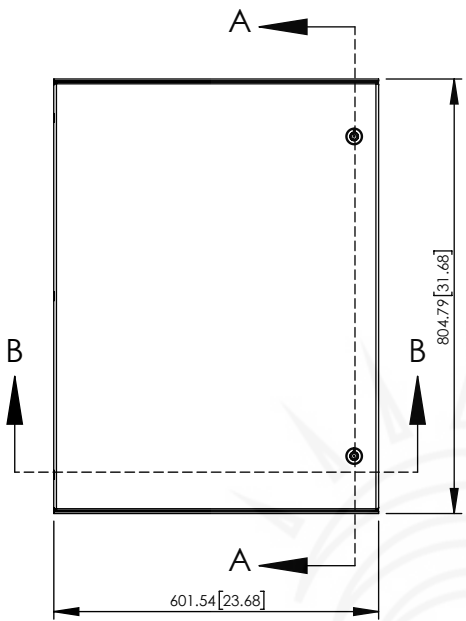
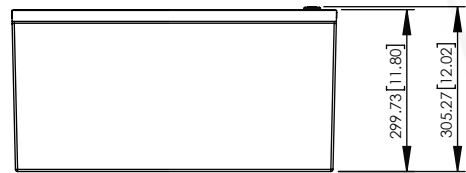
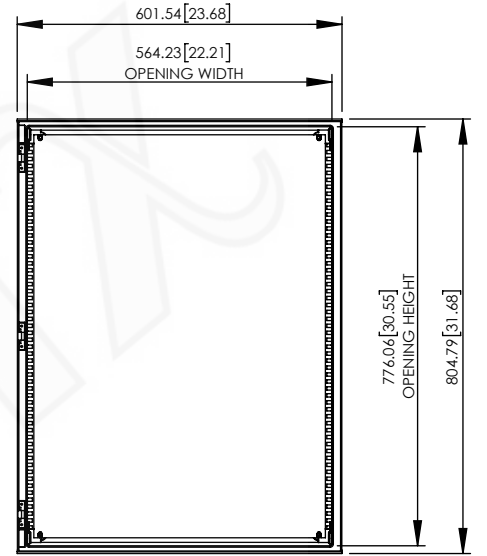
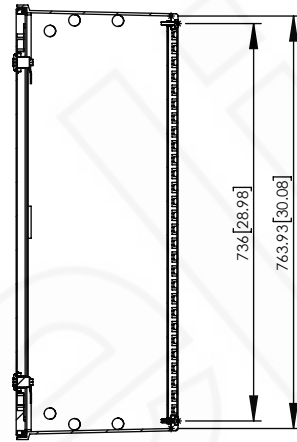

SECTION B-B

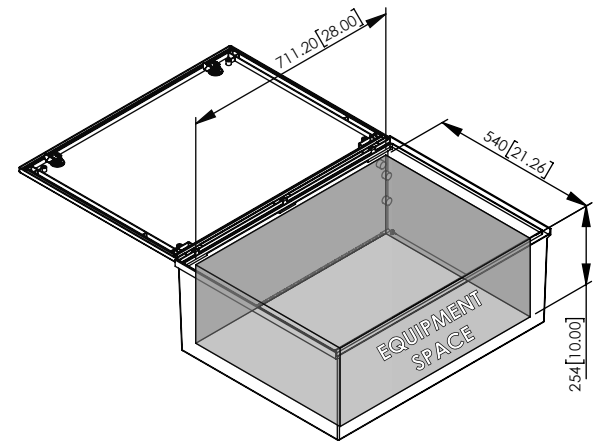
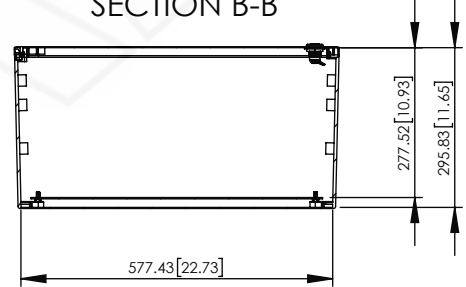

NO.	DESCRIPTION	MATERIAL	FINISH	QTY.
8	-	-	-	-
7	-	-	-	-
6	-	-	-	-
5	-	-	-	-
4	-	-	-	-
3	-	-	-	-
2	-	-	-	-
1	-	-	-	-

UNLESS OTHERWISE SPECIFIED:  
 DIMENSIONS ARE IN MILLIMETERS.  
 DIMENSIONS IN [ ] ARE IN INCHES AND  
 ARE FOR CUSTOMER REFERENCE ONLY.

TOLERANCES FOR MILLIMETERS:  
 0.5-8mm ± 0.20mm  
 8-30mm ± 0.40mm  
 30-120mm ± 0.50mm

TASK	NAME	DATE
DRAWN BY	N. COLUCCI	11/27/08
CHECKED	-	-
APPROVED	-	-

**Altelix**  
 www.altelix.com

1201 Clint Moore Road  
 Boca Raton, FL 33487  
 TEL: 561-660-WIFI

PART DESCRIPTION		32 X 24 X 12 NEMA ENCLOSURE WITH MOUNTING PLATE	
PART NUMBER		NFC322412P	
DRAWING NUMBER		DRW-NFC322412P	
SCALE:	1:13	REV:	A
		SHEET 1 OF 1	